

Data Sheet



Article number: 20957443

Description: E+G Levelling foot
GN 343.3-32-M10-A

Measures

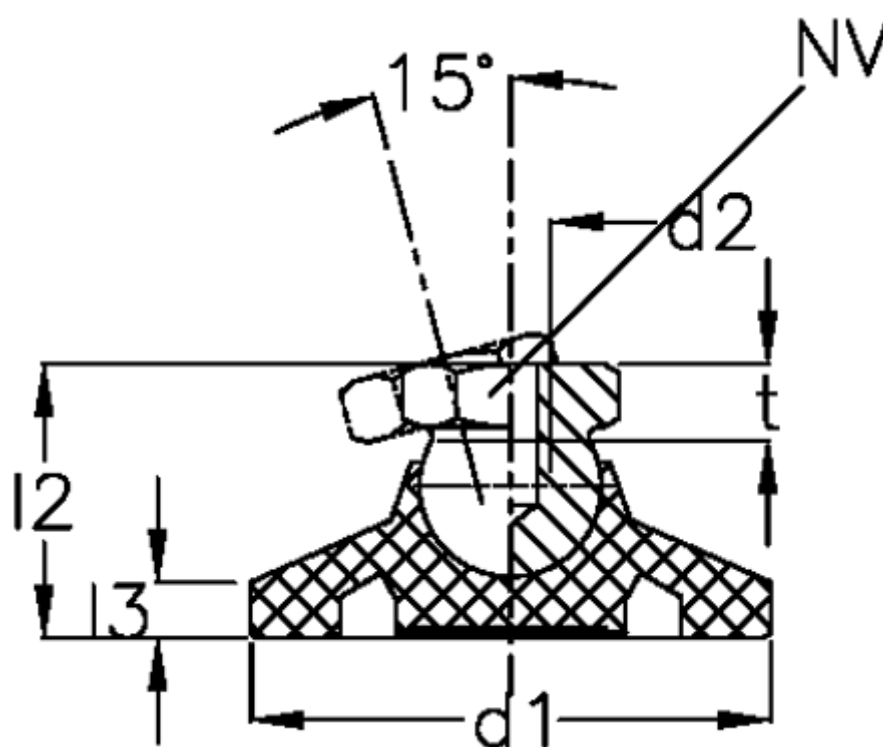

d1	= 32
d2	= M10
l2	= 22.5
l3	= 5.0
NV	= 15.0
Static load (N)	= 7000
t min	= 10.5